

DIN 2080, AUSGEWUCHTETES SPANNFUTTERGEHÄUSE, MIT
ABSAUGSCHLITZ FÜR WERKZEUGE. AUSWUCHTDREHZAHN 12.000
RPM.

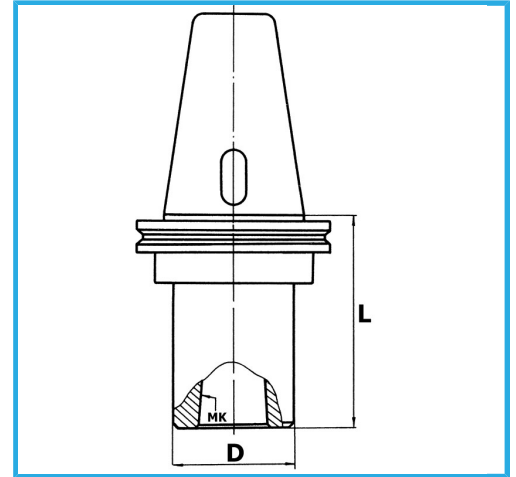

ISO	40
CM	3
D	40 mm
L	65 mm
Bruttogewicht	0,97 kg
EAN-Code	8012667407162



Box



Gehärtet